

# Santa Susana Field Laboratory Groundwater Investigation

February 8, 2007

Thomas Seckington, P.G., C.H.G.  
Senior Engineering Geologist  
California Environmental Protection Agency  
Department of Toxic Substance Control  
[tseckington@dtsc.ca.gov](mailto:tseckington@dtsc.ca.gov)  
(714) 484-5424



# Presentation Outline

- Review of the Current Site Data
- Site-wide Groundwater Characterization Activities
- Review of Group 6 Area RFI Report



# The Role of the Project Hydrogeologist

- Guide Groundwater Characterization Activities
- Review/Modify Work Plans submitted by Boeing
- Review and Evaluate Annual/Quarterly Groundwater Reports, Characterization Reports
- Oversee field work/collect split samples



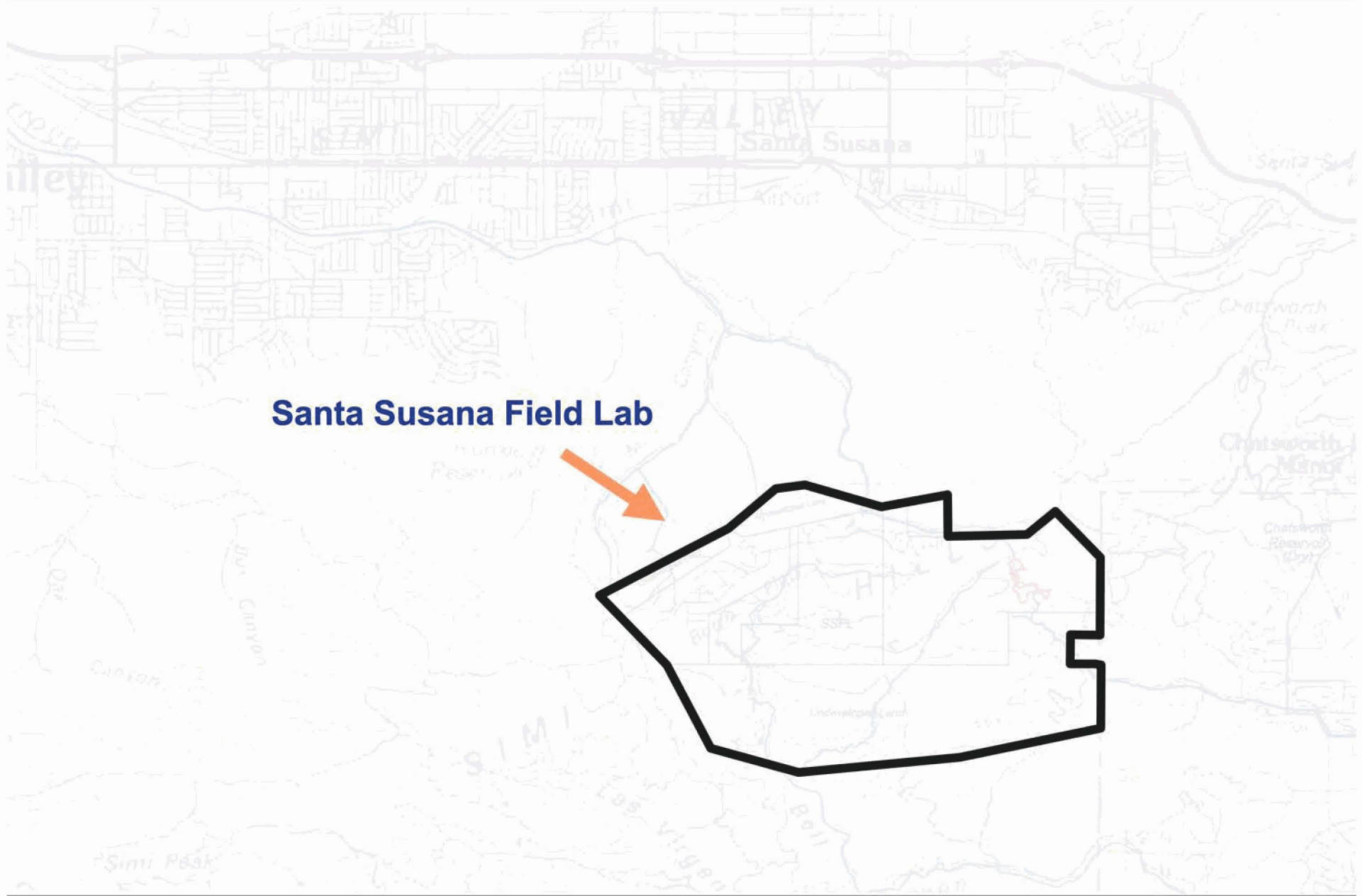

**Santa Susana Field Lab**



# Summary of Groundwater Data Trichloroethene (TCE)

- Solvent
- Estimated that over 500,000 gallons went into the ground.
- Used in large quantities at the test stands
- Detected in 355 of 425 wells sampled at the site.
- Highest concentration detected was 110,000 ppb in RD-35A.



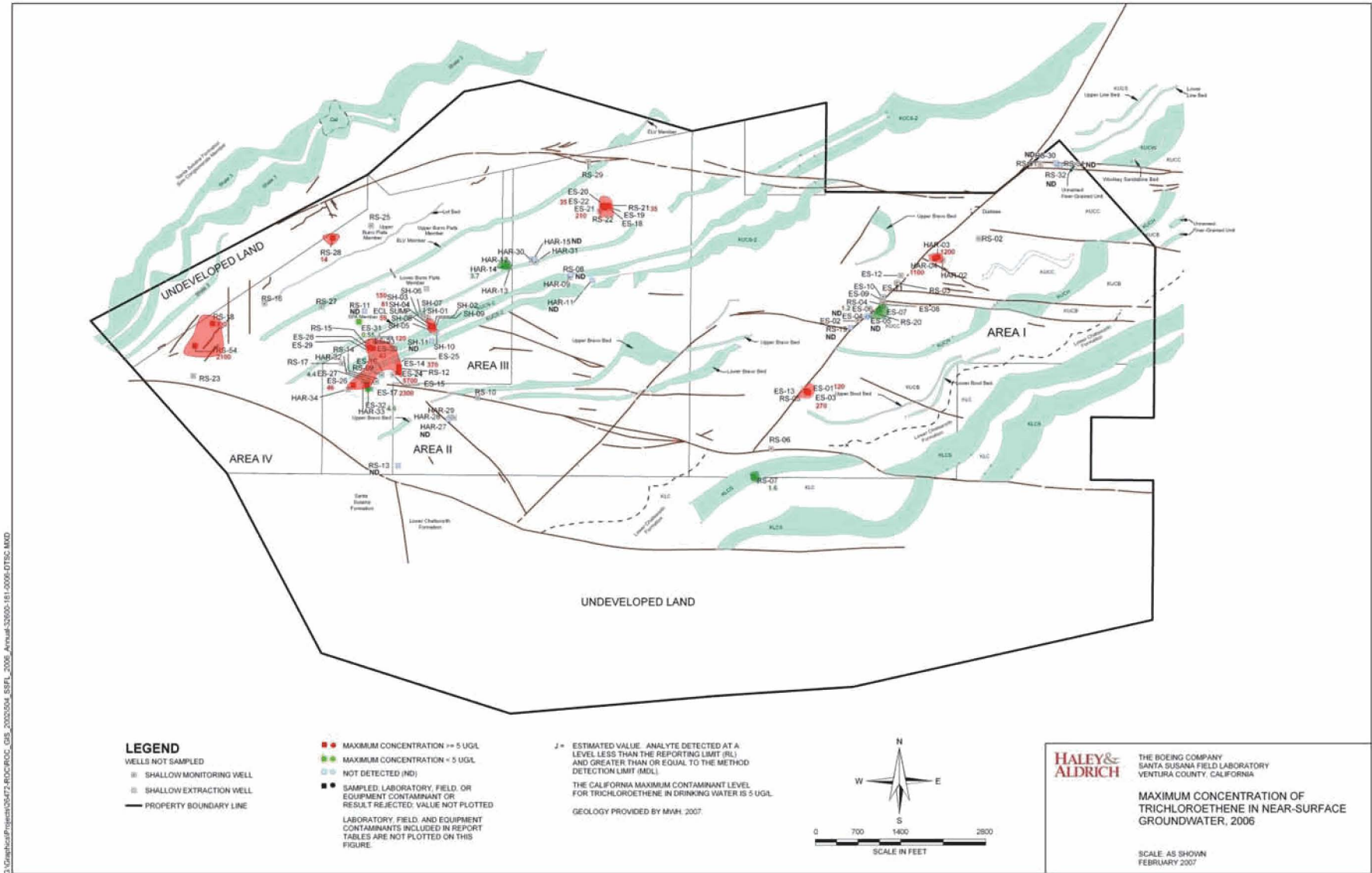

Shading was added to the figure to highlight areas with wells containing detected concentrations. The shaded areas should not be considered interpretations of the locations and extent of groundwater contaminant plumes. Basemap is from the 2006 Annual Groundwater Report for Santa Susana Field Laboratory by Haley & Aldrich



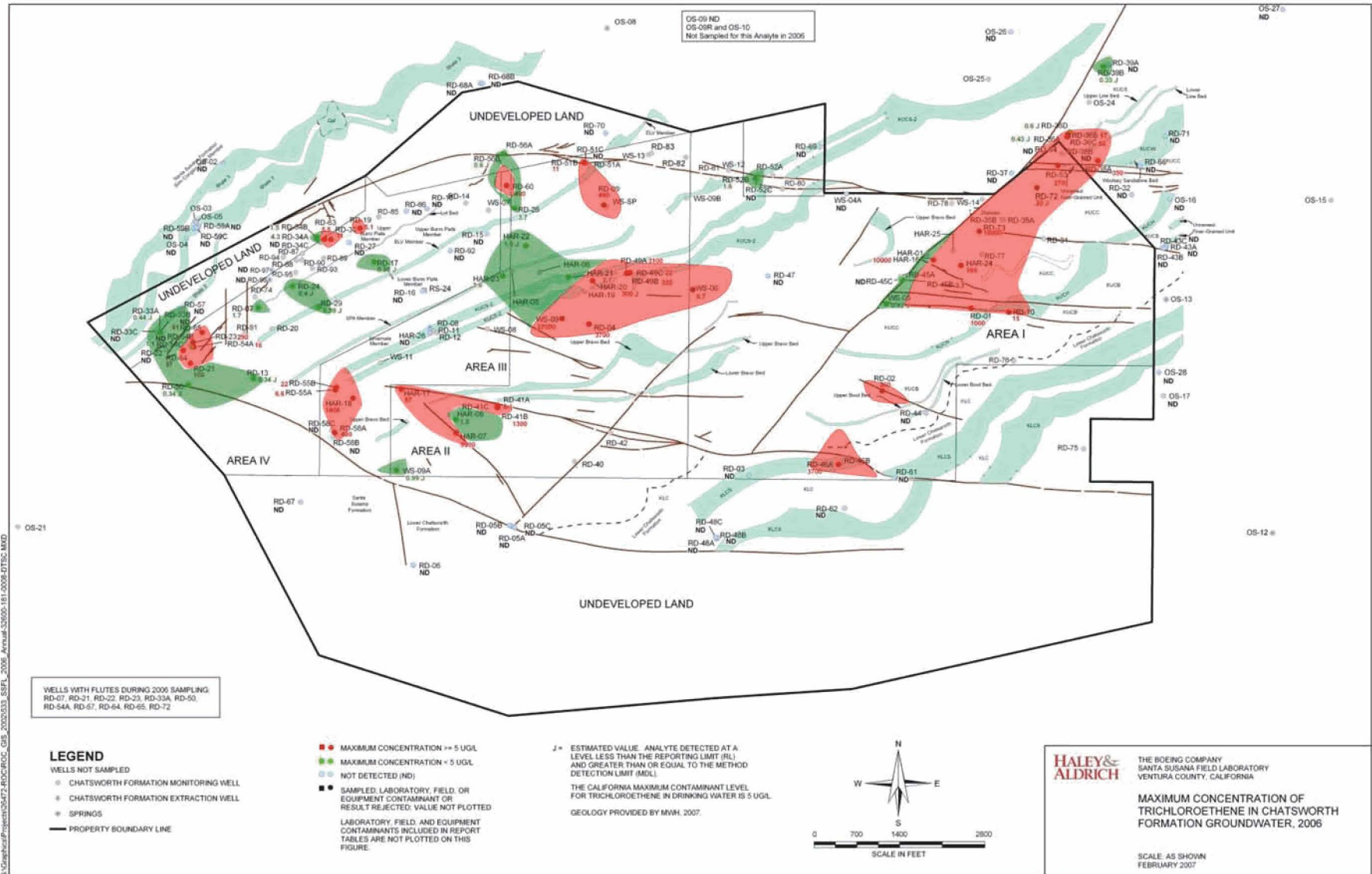

Shading was added to the figure to highlight areas with wells containing detected concentrations. The shaded areas should not be considered interpretations of the locations and extent of groundwater contaminant plumes. Basemap is from the 2006 Annual Groundwater Report for Santa Susana Field Laboratory by Haley & Aldrich



DEPARTMENT OF TOXIC SUBSTANCES CONTROL



# Summary of Groundwater Data Perchlorate

- Perchlorate was used in the Building 356 area and Happy Valley but has been detected in other areas at the site.
- Perchlorate is used in solid rocket propellants.
- It was detected in 56 of 277 wells.
- The highest concentration is 1,600 ppb in HAR-16.



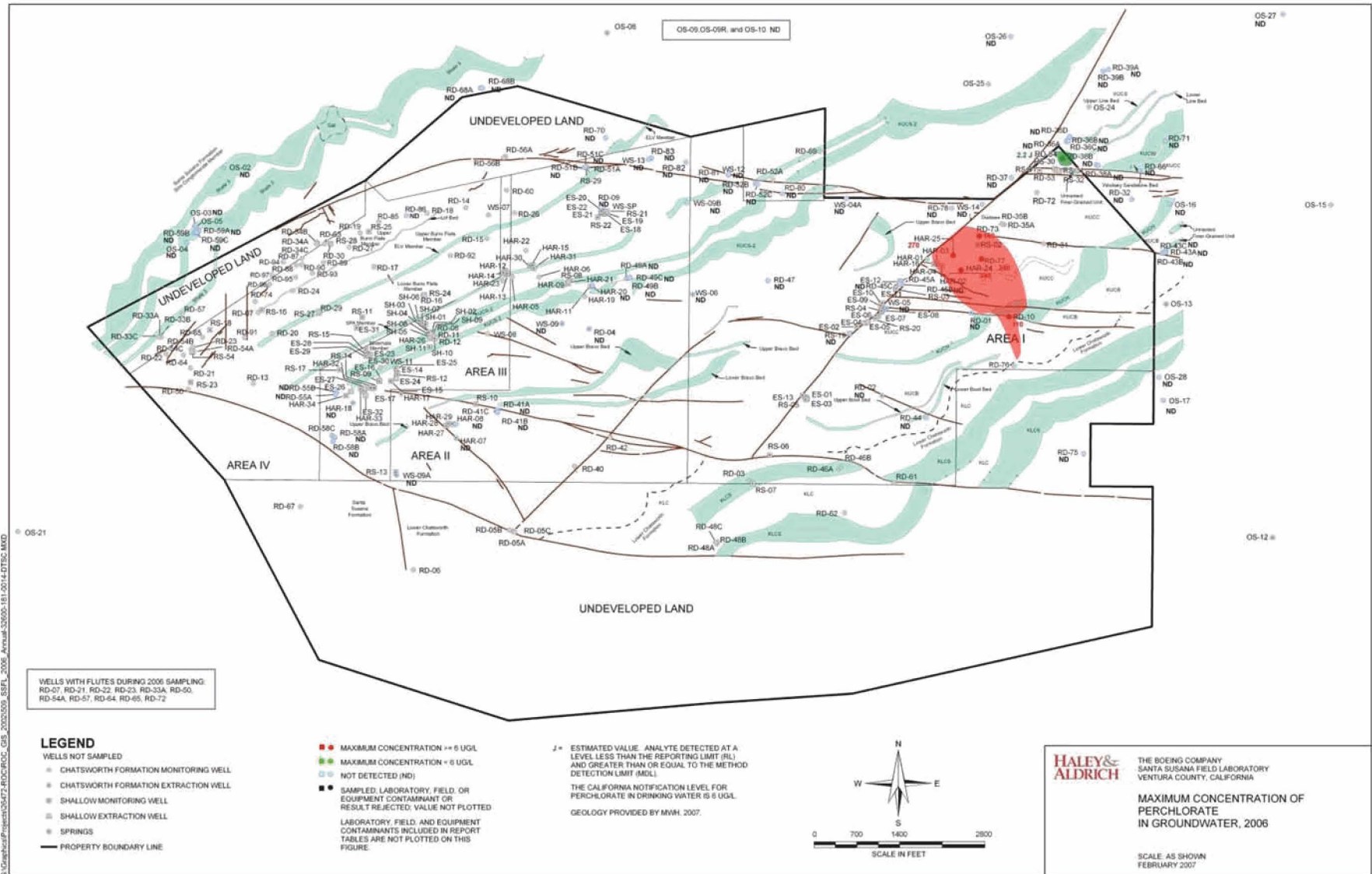

Shading was added to the figure to highlight areas with wells containing detected concentrations. The shaded areas should not be considered interpretations of the locations and extent of groundwater contaminant plumes. Basemap is from the 2006 Annual Groundwater Report for Santa Susana Field Laboratory by Haley & Aldrich





# Summary of Groundwater Data N-Nitrosodimethylamine (NDMA)

- NDMA is a product from the decomposition of unsymmetrical dimethyl hydrazine, a component used in the production of rocket fuel. This chemical is used as an additive in liquid propellant fuel for rocket engines. NDMA is used primarily in research, but it can also be formed inadvertently in a number of industrial processes.
- NDMA was detected in 75 of 232 wells sampled at the site;
- Highest concentration detected is 110 parts per billion in SH-04.



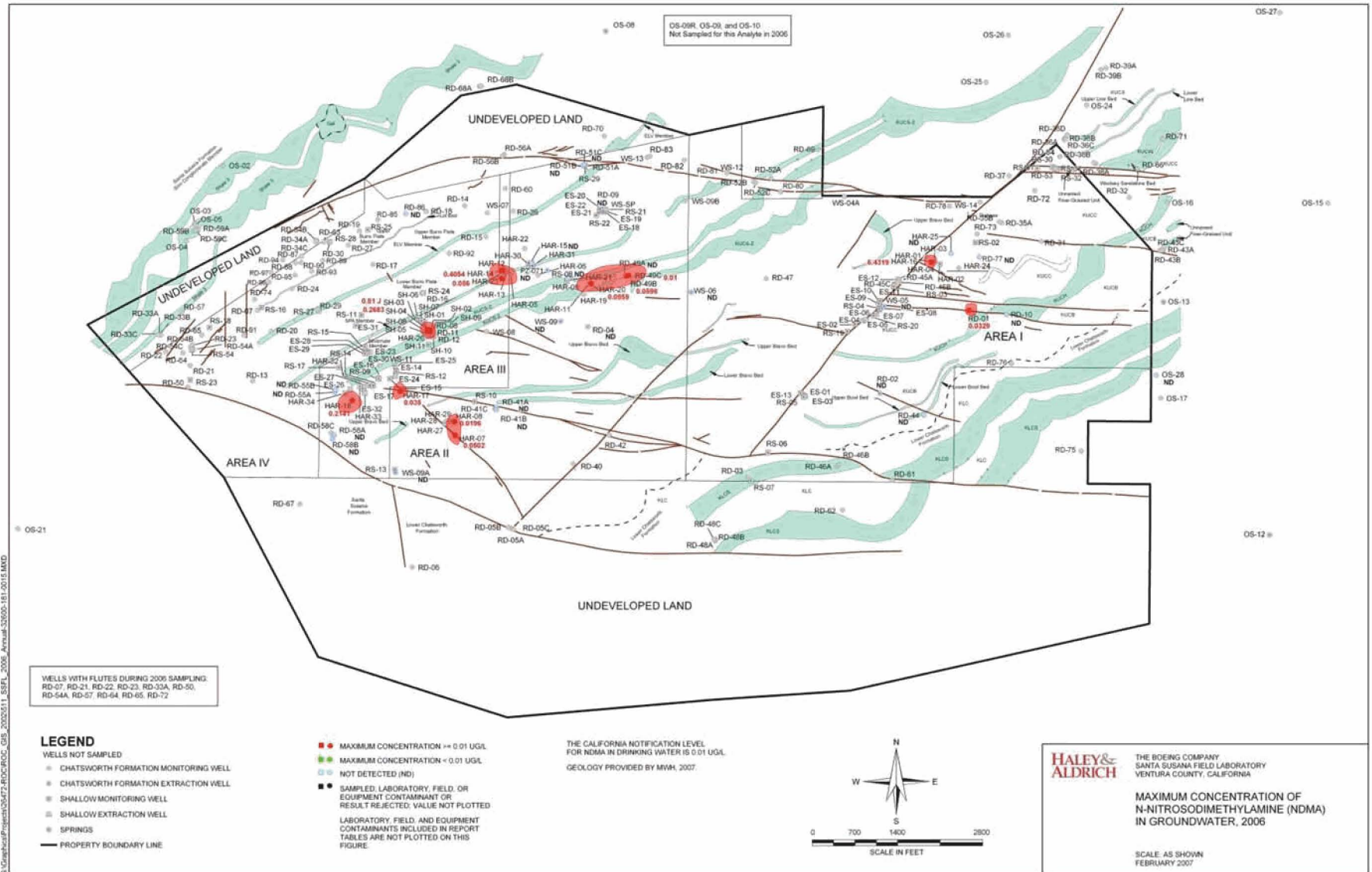

Shading was added to the figure to highlight areas with wells containing detected concentrations. The shaded areas should not be considered interpretations of the locations and extent of groundwater contaminant plumes. Basemap is from the 2006 Annual Groundwater Report for Santa Susana Field Laboratory by Haley & Aldrich



# Summary of Groundwater Data Vinyl Chloride

- Vinyl Chloride is a breakdown product of TCE.
- Detected in 122 of 424 wells sampled.
- Highest concentration detected in 3,900 ppb in SH-04.







# The Need for More Detail

## Simple Interpretation:

Plume - homogeneous and defined from wells

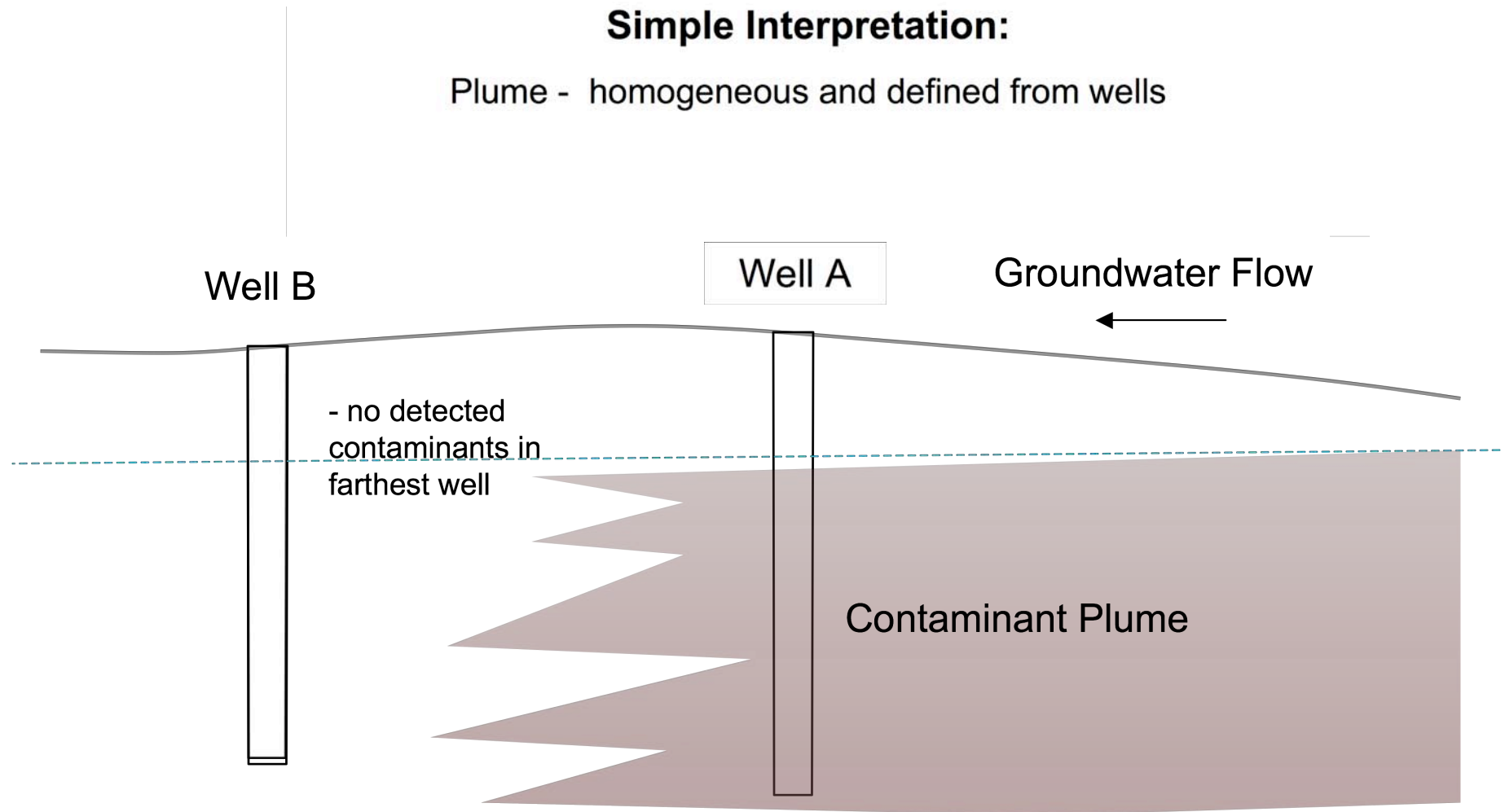



# The Need for More Detail

## Current Understanding

- plume and groundwater are strongly influenced by the geology
- the distribution of contaminants is complex and placement and construction of wells is critical

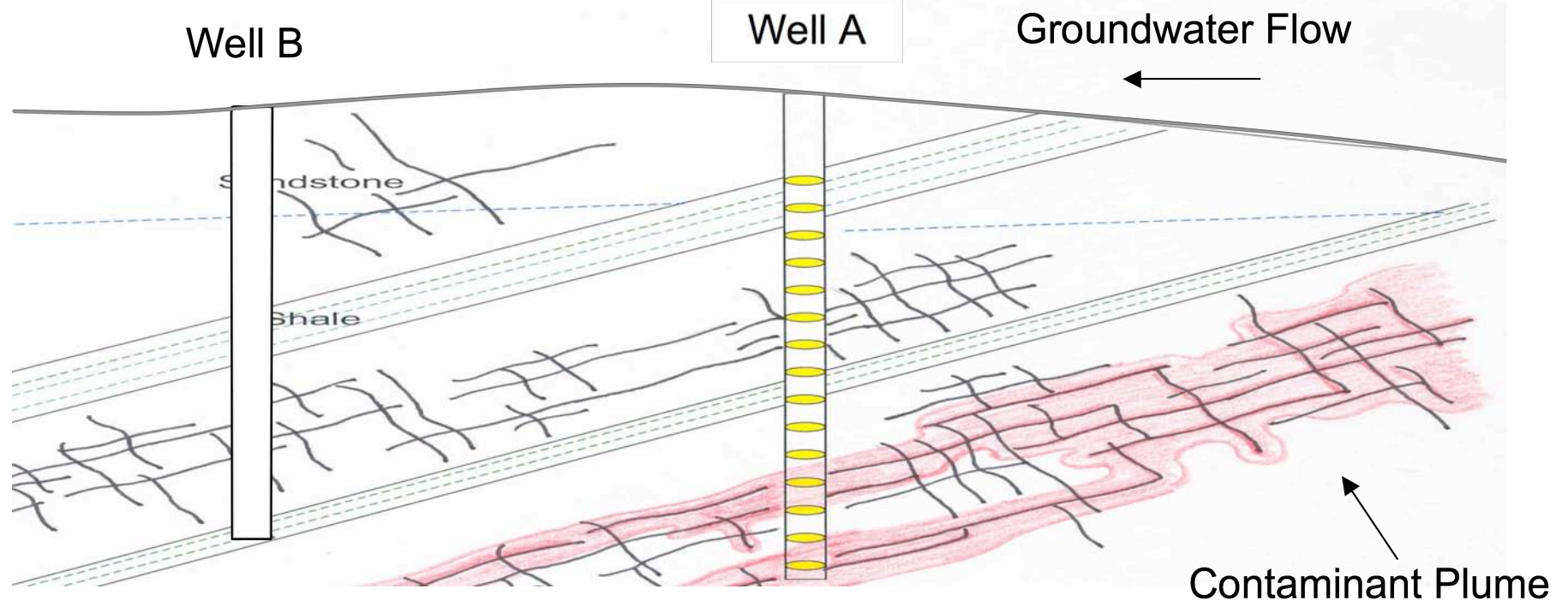

# Discrete depth sampling

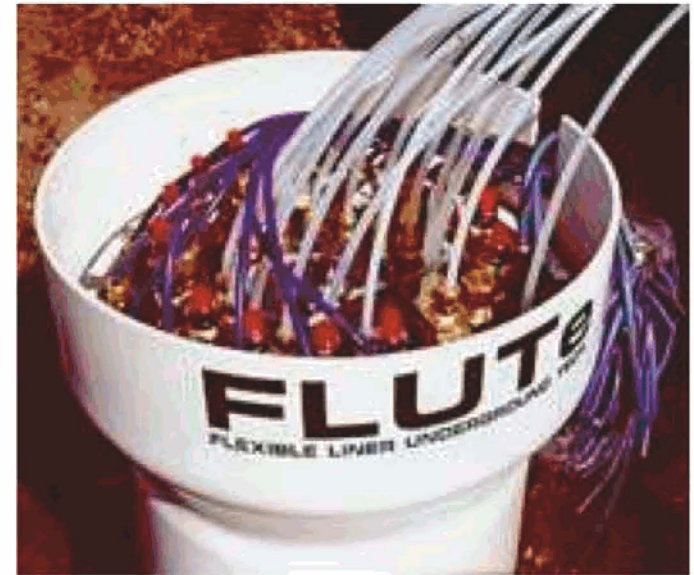



# Corehole Drilling and Sampling

- Coreholes provide details about the rock types and the nature of the fractures



- 100s of samples are collected from each core and analyzed for volatile organic compounds providing detailed profiles of the chemicals in the rock.





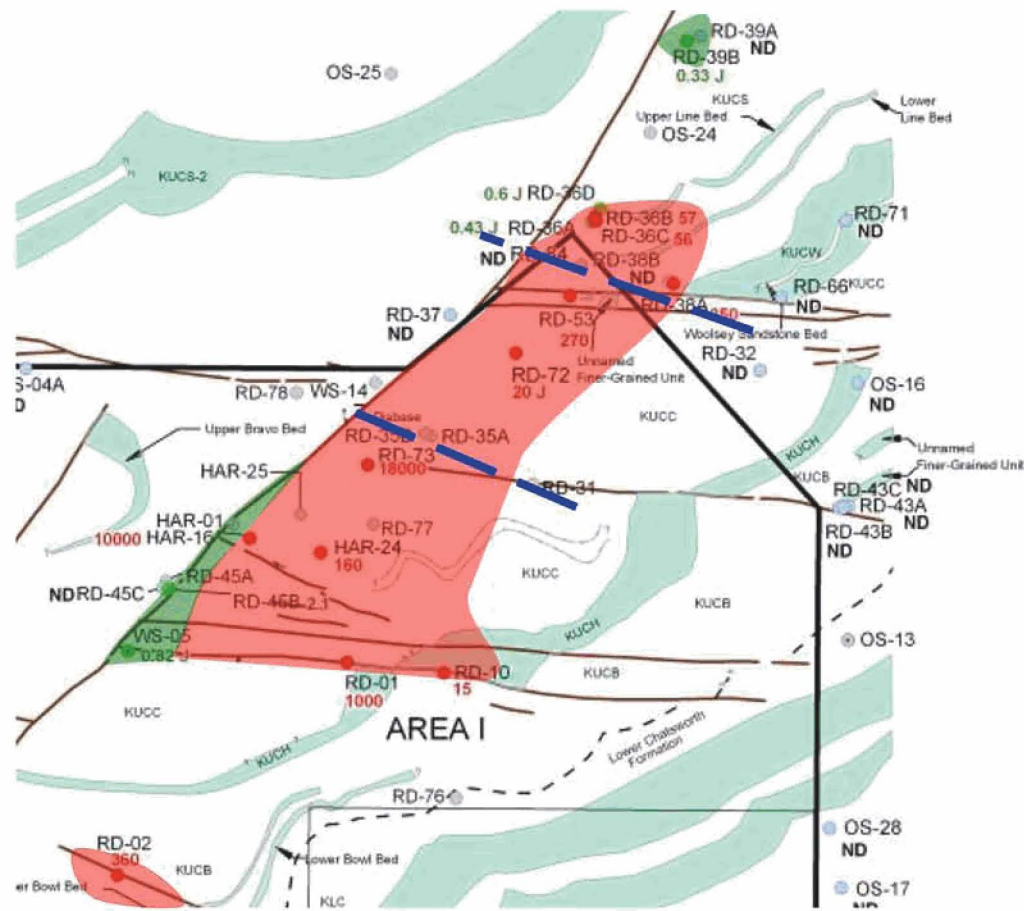

Shading was added to the figure to highlight areas with wells containing detected concentrations. The shaded areas should not be considered interpretations of the locations and extent of groundwater contaminant plumes. Basemap is from the 2006 Annual Groundwater Report for Santa Susana Field Laboratory by Haley & Aldrich







Groundwater

Finer grained unit

Faults

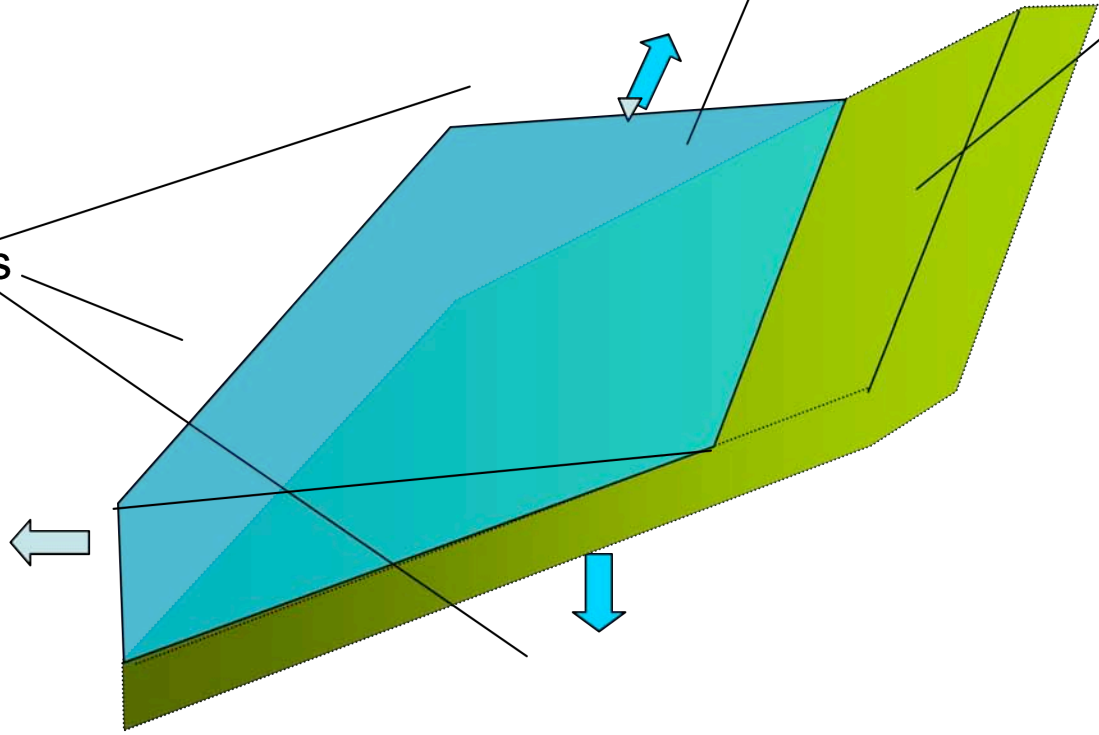

Groundwater

Finer grained unit

Faults

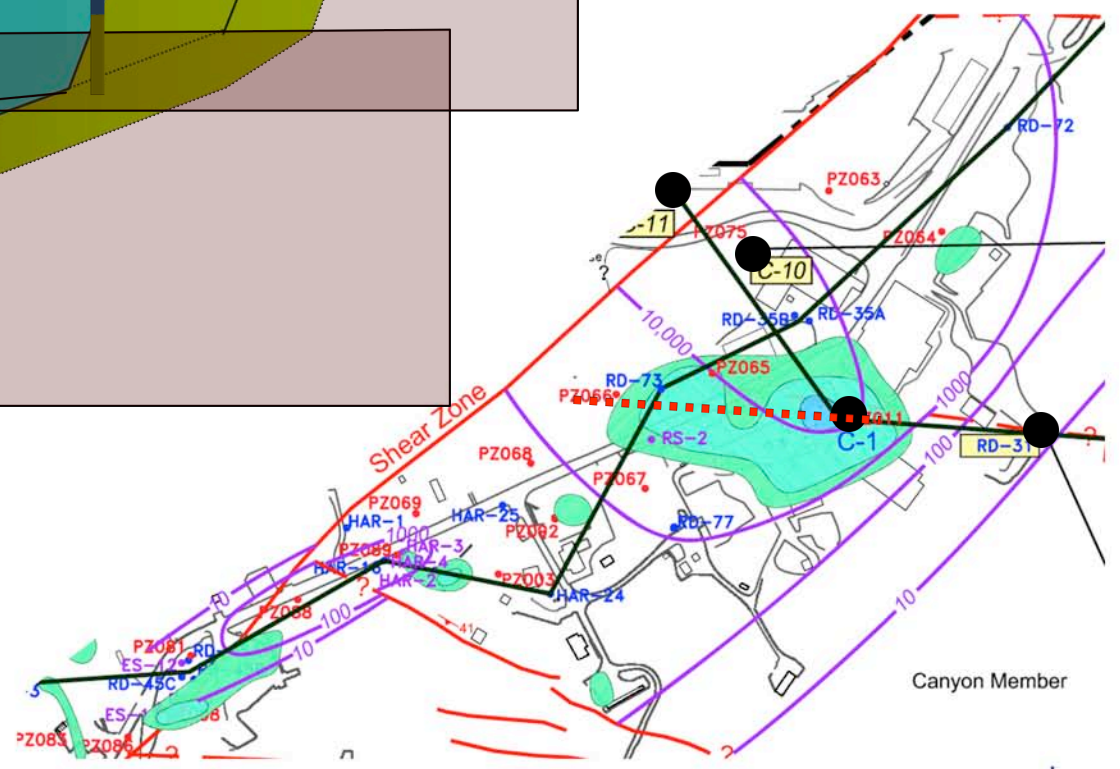
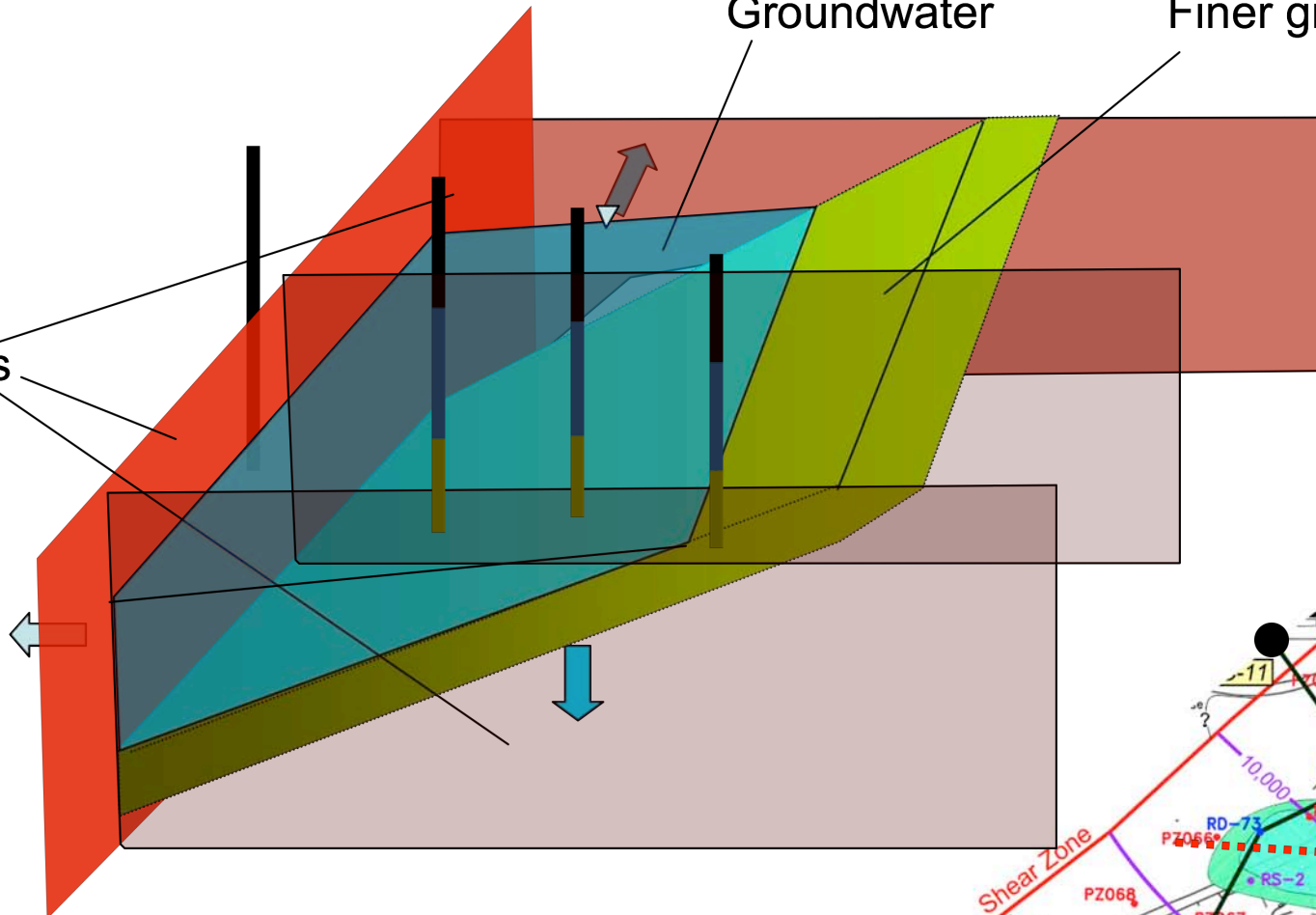

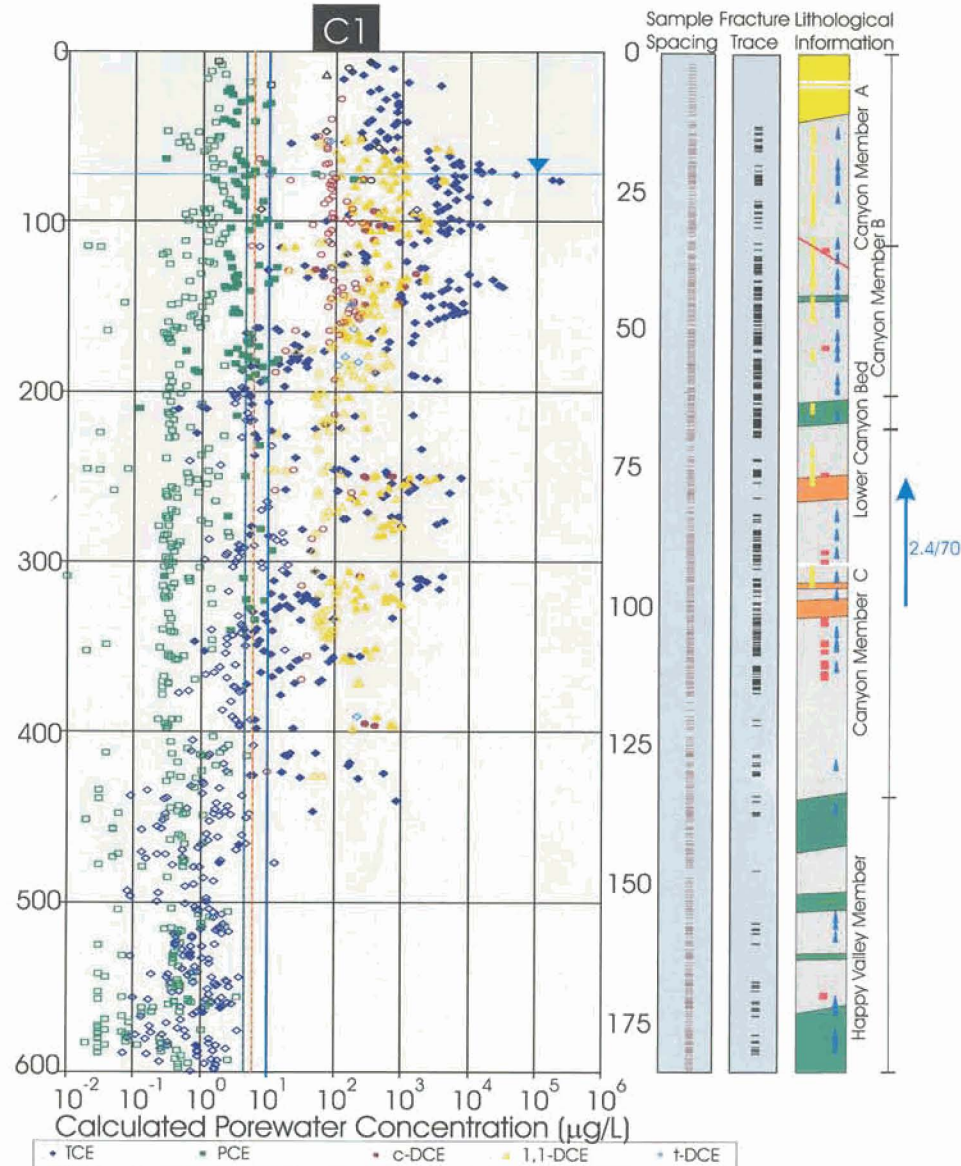

Figure 44. C1 (Instrument Equipment Lab) Profile of TCE Porewater Concentrations

Solid lines represent analyte maximum contaminant levels for drinking water for the state of California. Open symbols represent values that are estimates (fall between the method detection limit and the method reporting limit). Solid symbols represent quantitative values. Non-detects are not plotted. All concentrations are below TCE solubility (~1.4x10<sup>6</sup> µg/L porewater).





# Aquifer Tests

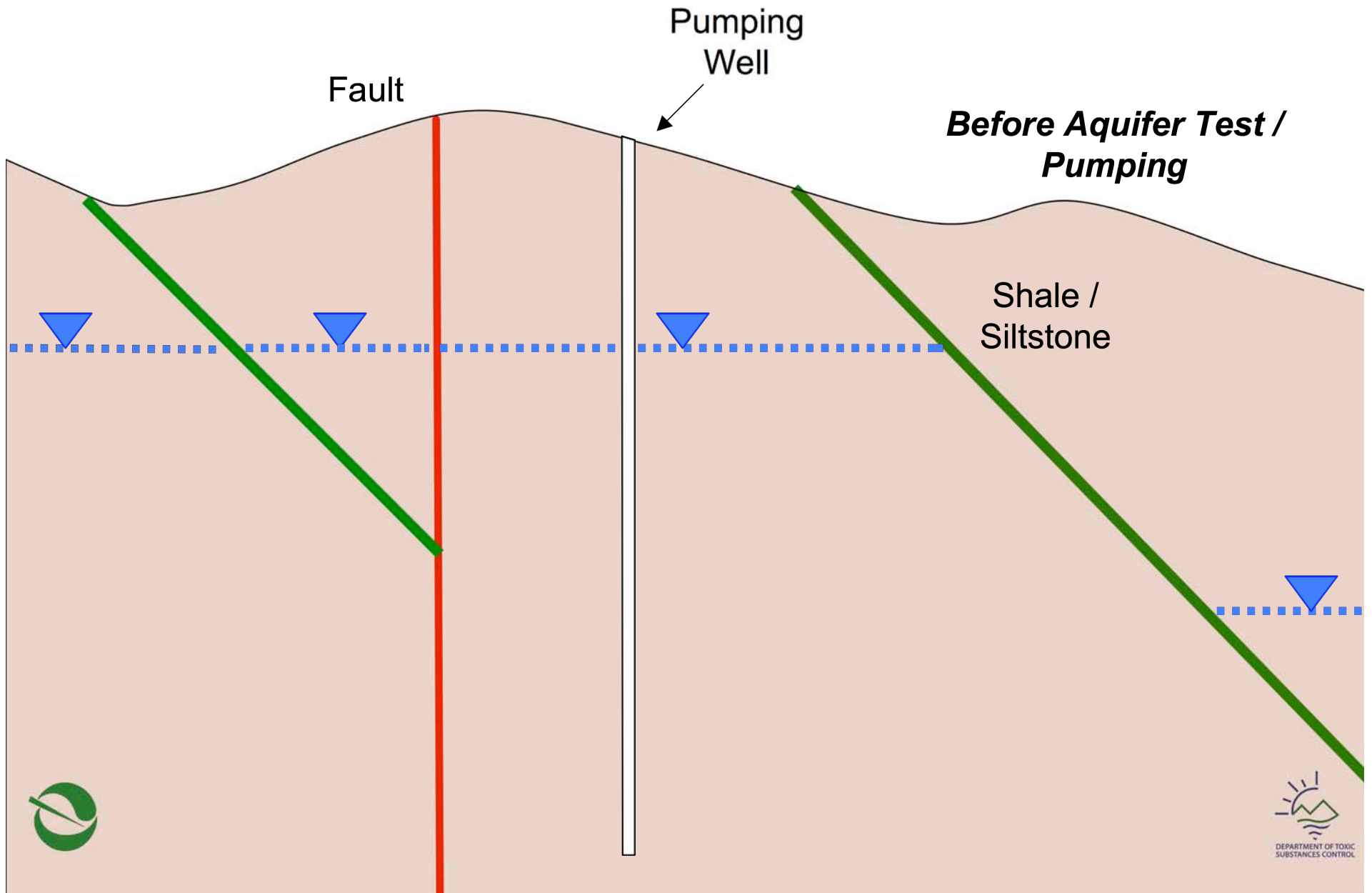



# Aquifer Tests

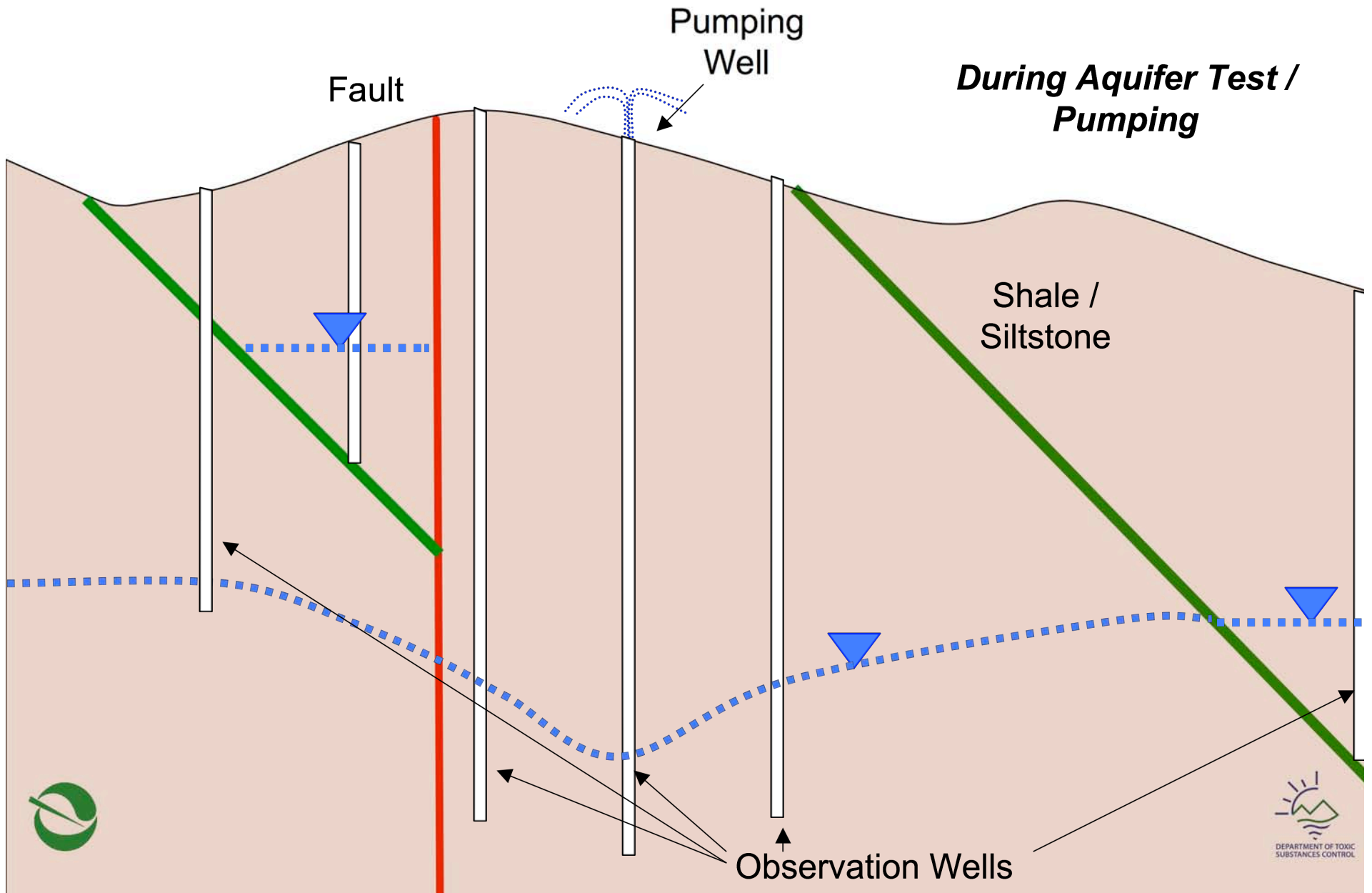

# Seeps/Springs Sampling

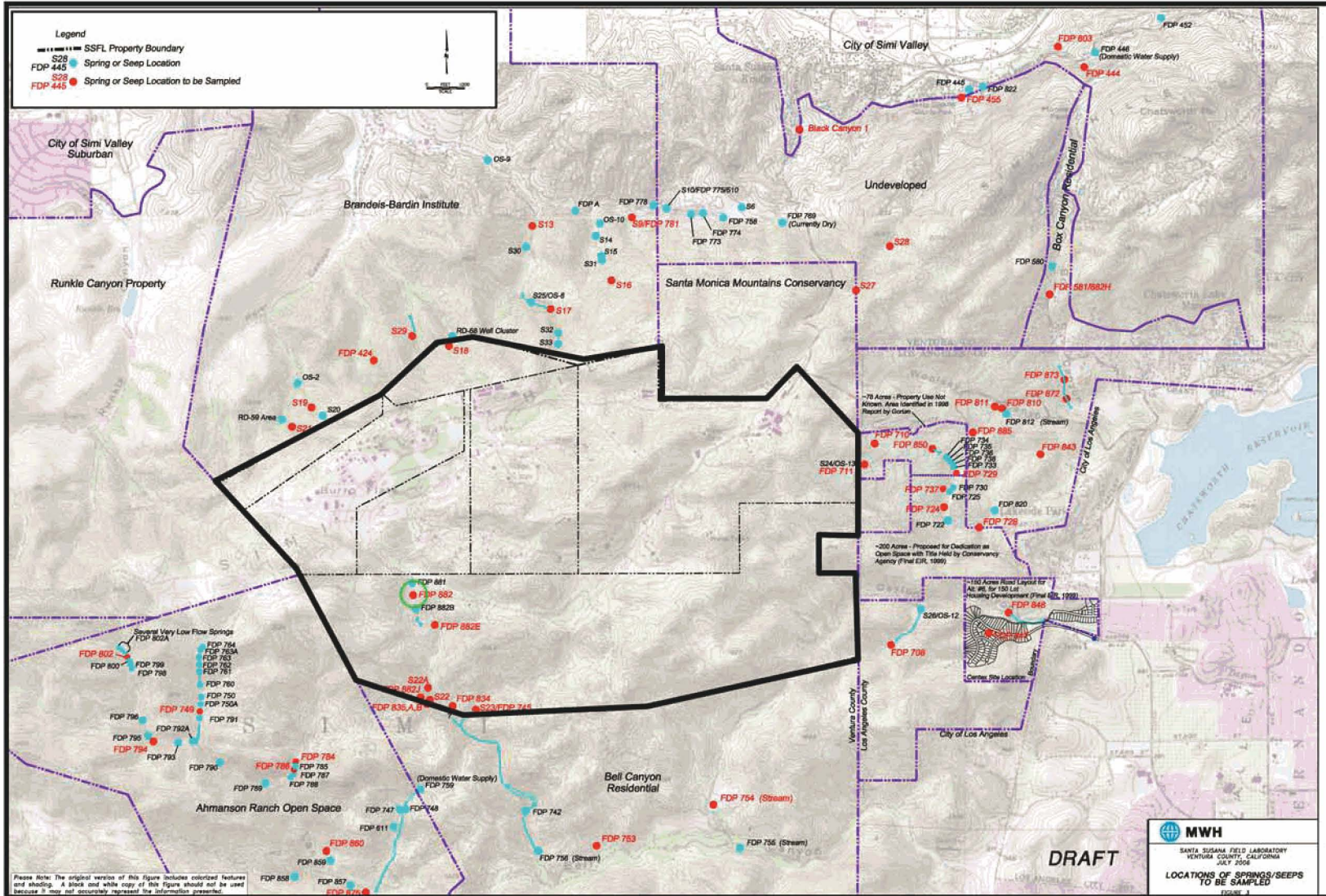



# Seeps/Springs Sampling

Date Sampled	Spring/Seep	8260B	Perchlorate
8/21/2006	FDP-170		ND
8/21/2006	FDP-781		ND
8/22/2006	S-16	ND	ND
8/22/2006	S-17	ND	ND
8/22/2006	S-18	ND	ND
8/22/2006	S-29	ND	ND
8/22/2006	FDP-455		ND
8/22/2006	FDP-494		ND
8/23/2006	FDP-924	ND	
8/23/2006	S-27	ND	
8/23/2006	FDP-207	ND	
8/24/2006	FDP-860	ND	ND
8/24/2006	FDP-858	ND	ND
8/24/2006	FDP-875A	ND	ND
8/24/2006	FDP-753	ND	ND
8/28/2006	FDP-890	ND	ND
8/29/2006	FDP-893	TCE- 93 ppb; 1,1-Dichloroethene- 1.1 ppb; cis-1,2-Dichloroethene - 390 ppb; trans-1,2-Dichloroethene -17	
8/29/2006	FDP-784A	z	
8/30/2006	S22-A	ND	ND
8/30/2006	FDP-882J		ND
8/30/2006	FDP-835A	ND	ND
8/31/2006	FDP-749A	ND	ND
8/31/2006	FDP-891	ND	ND
10/2/2006	FDP-580	ND	ND
10/2/2006	FDP-581	ND	ND





# Future Investigation

- These approaches are providing the information we need to determine where the contaminants are and how far they have moved.
- These approaches will be extended across the site so that, at the end of the investigation, we know the nature and extent of contamination across the site.



# Group 6 Area Report Objectives

## Detailed evaluation of the groundwater flow and analytical data

- Is there sufficient monitoring well coverage around potential source areas?
- Have ALL the potential chemicals been analyzed in the right places during an adequate monitoring period?
- Are the groundwater contaminant plumes characterized?
- Are there ANY chemical data that are not consistent with what is known about Group 6 area?



# Preliminary Conclusions

## Group 6 Groundwater

- I have already identified groundwater data gaps and have directed Boeing to collect additional chemical data (such as hexavalent chromium).
- I will be requiring Boeing conduct to a more detailed investigation into the groundwater flow in the Group 6 report.





# Closing

- Questions?

Phone: (714) 484-5424

Email: [Tseckington@dtsc.ca.gov](mailto:Tseckington@dtsc.ca.gov)

